



Koks – ilgtspējīgs būvmateriāls. Latvijas un pasaules pieredze

Pēteris Supe

SIA "Rodentia" ēku būvinženieris

Ilgtspējīgas konstrukcijas

- Videi draudzīgs un atjaunojams materiāls (FSC)
- Zema ražošanas patērētā enerģija
- Ilgizturīga un racionāla konstrukcija

Nesošās konstrukcijas

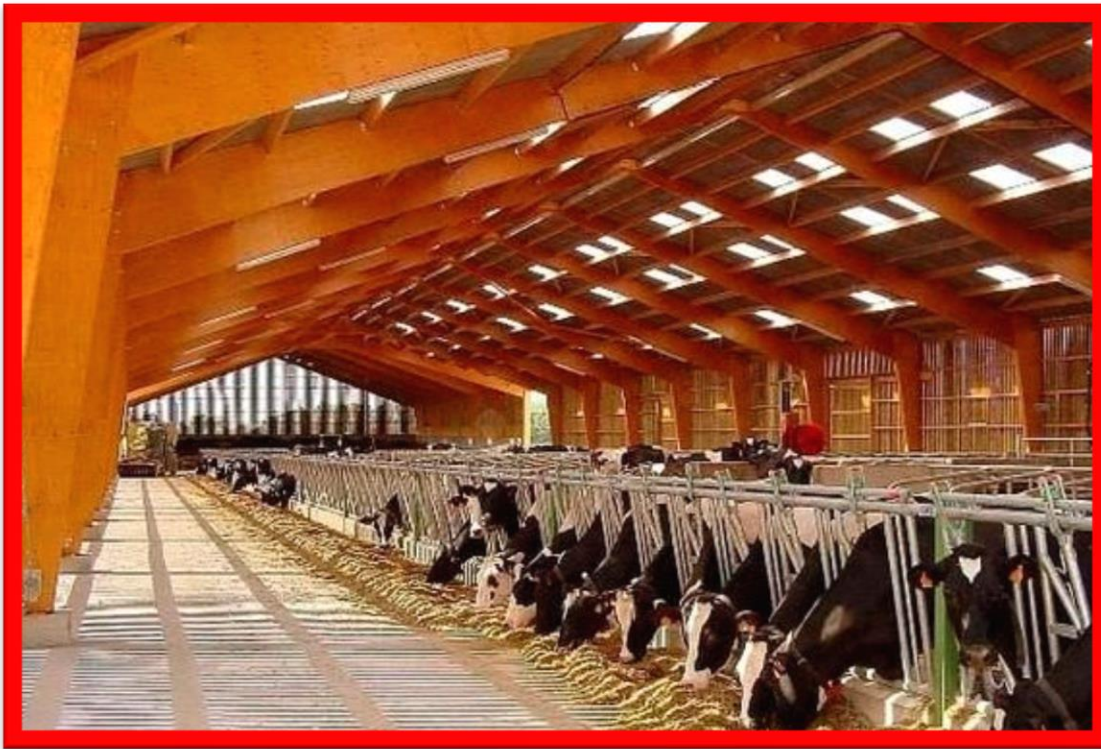

<https://i.pinimg.com/564x/e9/ec/22/e9ec22cec49b62eaf1cae5eb90e82a6b.jpg>



<https://i.pinimg.com/originals/25/26/4c/25264c1f97abf62ac7d1c29bd61897d1.jpg>

Nesošās konstrukcijas



<https://www.juresmedis.lt/uploads/images/Gallery/Incukalns/Incukalns1.jpg>



<http://arcwood.ee/en/p%C3%BChaj%C3%A4rve>

Nesošās konstrukcijas



http://www.bucklandtimber.co.uk/wp-content/uploads/2013/11/20151123_132022.jpg



Modernu risinājumu mezgli



<https://www.juresmedis.lt/sporto-paskirties-statiniai.html>



<http://www.moboa.fr/wikidocs-enseigne/image/LVLLAMIBOIS.jpg>

Modernu risinājumu mezgļi

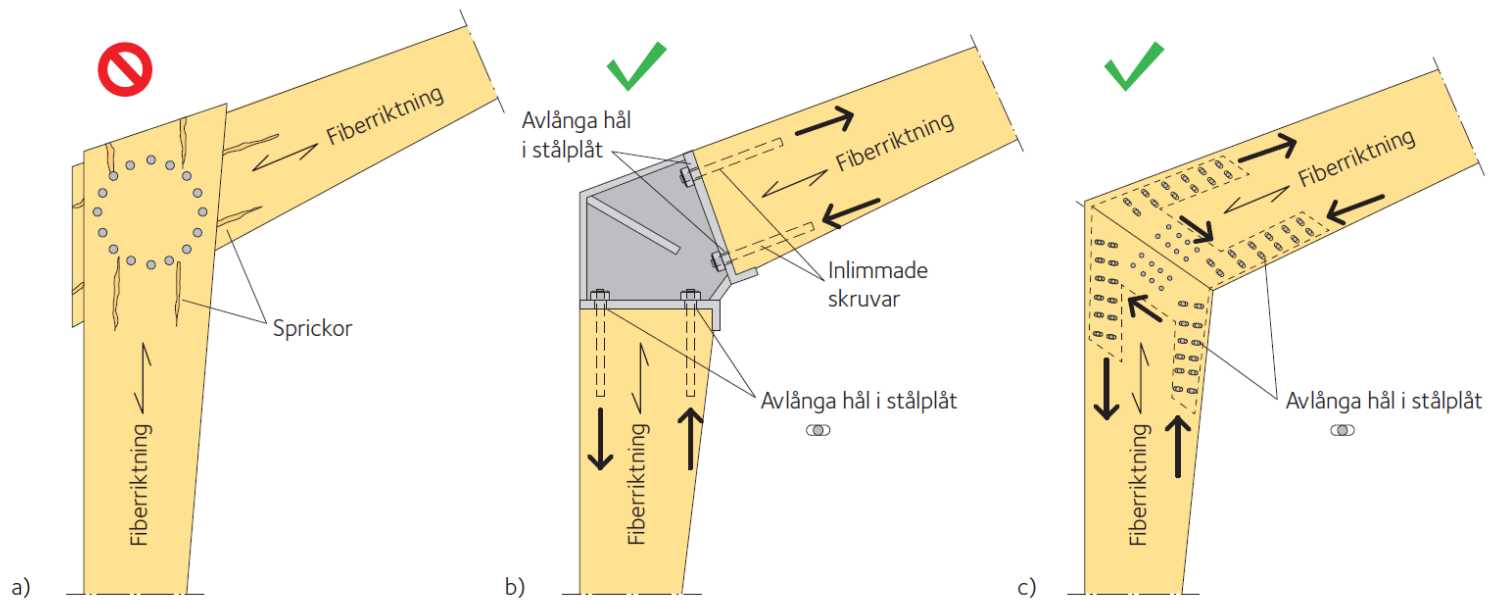

<https://www.svensktra.se/siteassets/6-om-oss/publikationer/pdf/limtrahandbok-del-2-svenska-2018.pdf>



©Rothoblaas

Modernu risinājumu mezgli

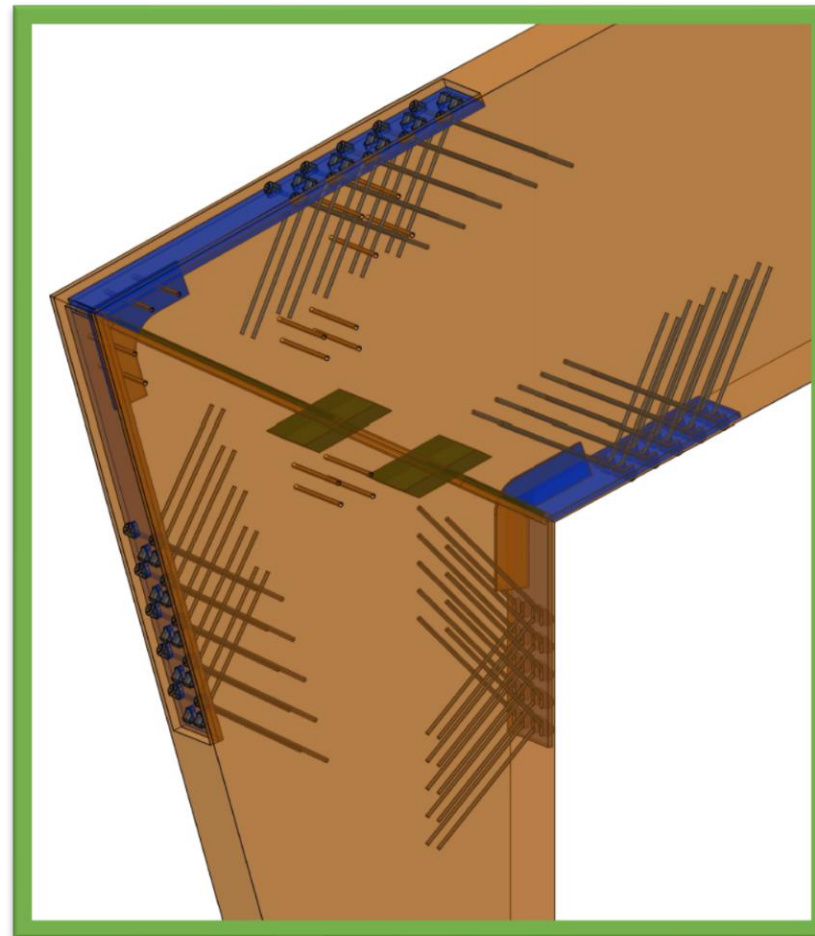
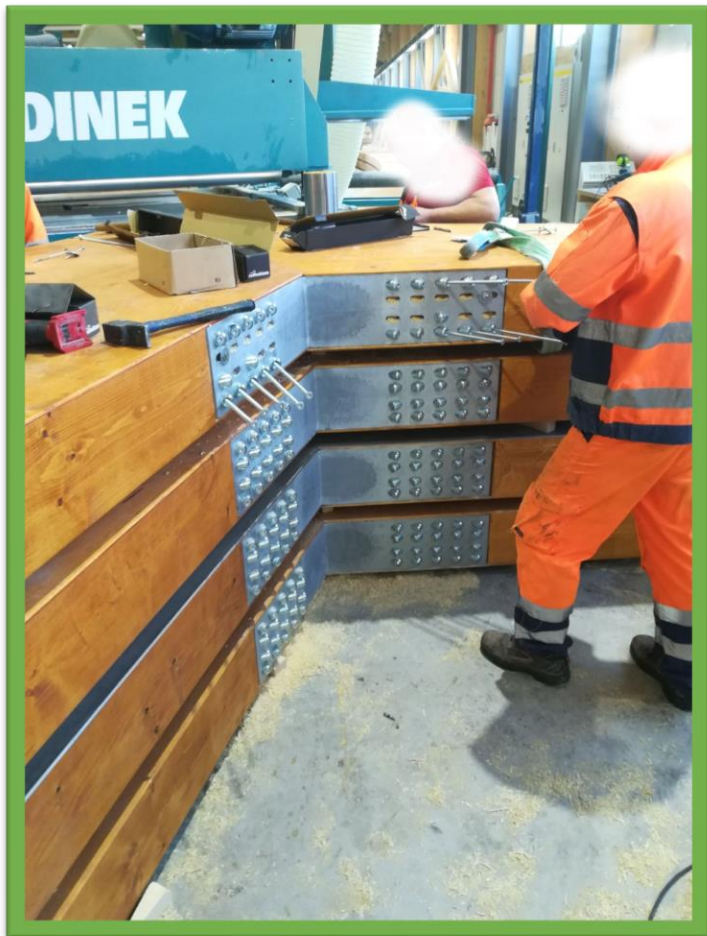

Modernu risinājumu mezgli



<http://www.uslumber.com/MainSite/Store1/StoreCategoryProductList/ProductList/1689>



©Rothoblaas

Modernu risinājumu mezgli



<https://www.neueholzbau.ch/it/produkte/gsa-technologie/lmv/>

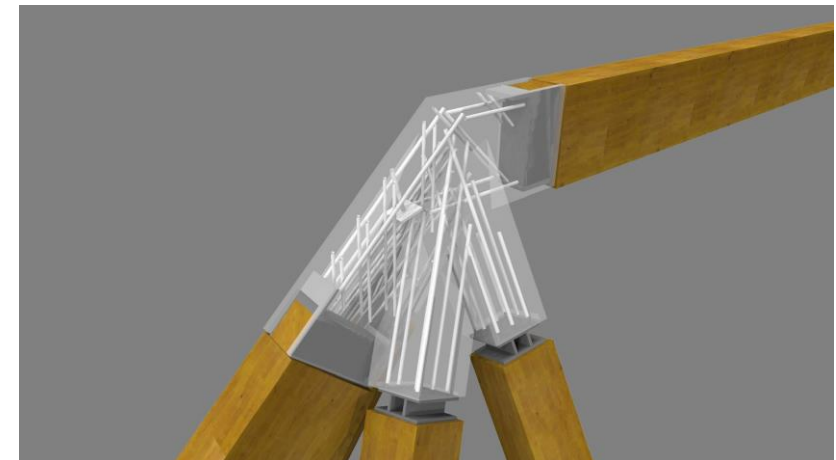
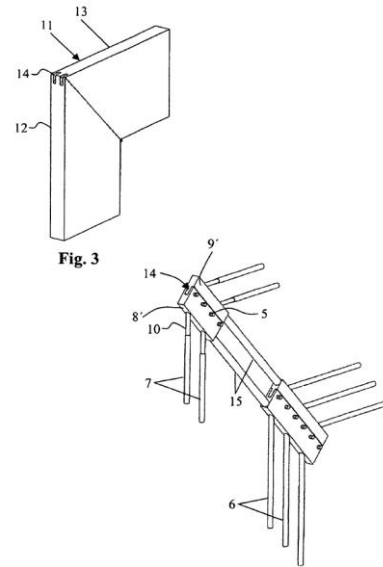

<https://structurecraft.com/projects/philip-j-currie-dinosaur-museum>

Arhitektūra



Arhitektūra

- BIM vai 3D DWG
- Atsevišķi faili - vienota koordinātu sistēma
- Liektās konstrukcijas!

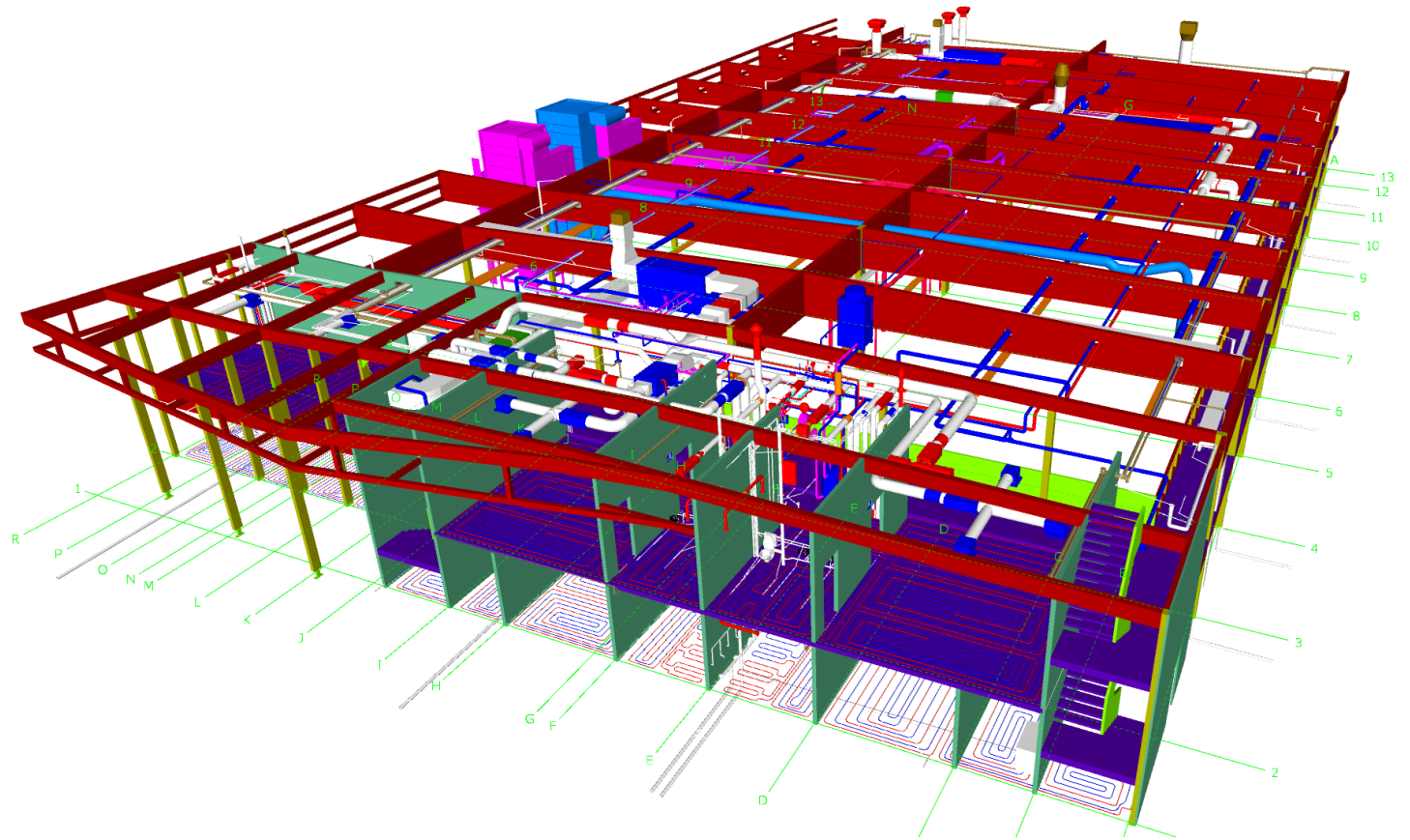

IKTK

- Lielākais šķērsriezums elementam 240x2100 mm (bez blokā līmēšanas)
- Lielākās dimensijas elementam 4.00x32.00 m (brīvi liektas konstrukcijas)
- CNC apstrāde 4.00x32.00 m



Ķīmiskā aizsardzība

- ~~• Antiseptiķis, antipirēns, dekoratīvā apdare~~
- Dekoratīvā ķīmiskā aizsardzībā ar antiseptiskām īpašībām
- Antipirēns (bez papildus apdarēm)

Ķīmiskā aizsardzība

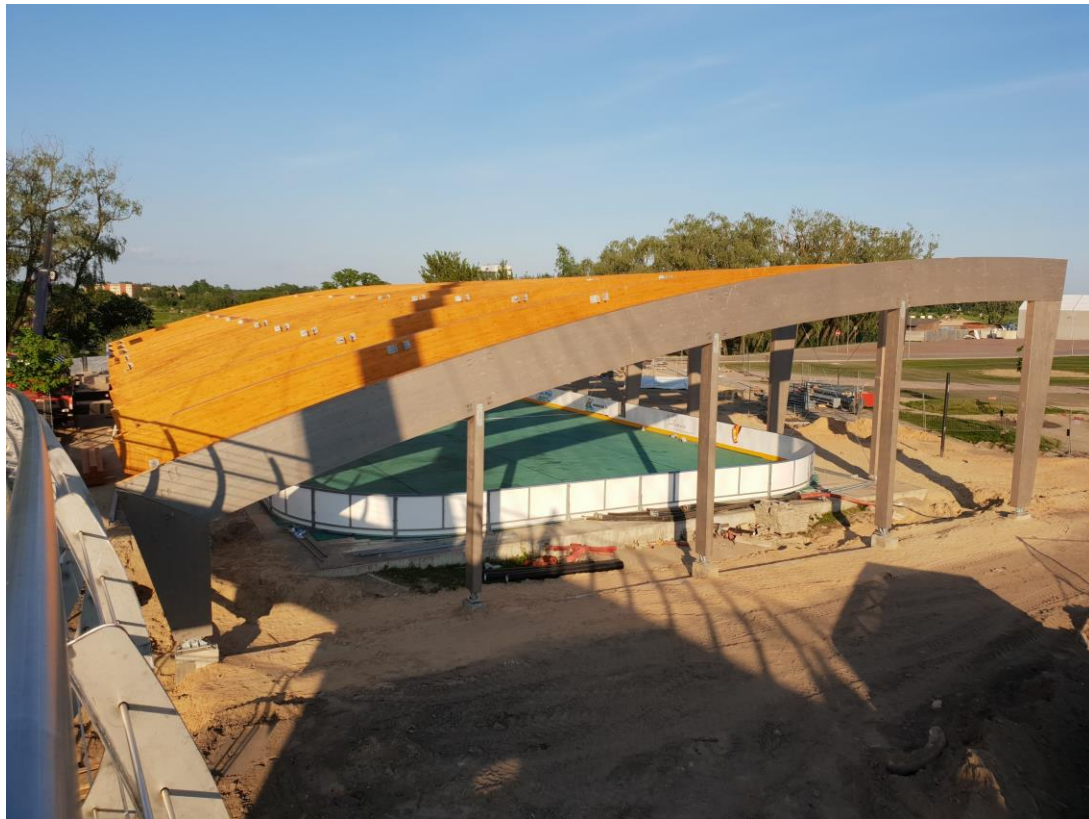

Konstruktīvā aizsardzība



https://www.schaffitzel.de/images/slideshow/brueckenbau/hoengesberg/resized/hoengesberg_1_sz-1600.jpg

Konstruktīvā aizsardzība





Koks – ilgtspējīgs būvmateriāls.
Latvijas un pasaules pieredze

Pēteris Supe

SIA “Rodentia” ēku būvinženieris

peteris.supe@rodentia.lv

+371 286 77 196